

# JSRFLP Series

## Pressure Reducing Valves for Low Flow and Low Pressure Biopharmaceutical and Parenteral Process Gas

JSRFLP is a high purity low flow, regulator designed and built specifically for very low pressure hygienic, ASME BPE gas applications.

The JSRFLP has been designed specifically for very low pressure clean gas regulation in Stainless and Single Use Disposable applications. Whether it's precise regulation for sparging, blanketing, motive force, or SUD bag inflation, the JSRFLP was built for the job!

The durable valve body and metal trim components are machined from ASTM A479 316L SST barstock and finished to ASME BPE SF5, 20Ra micro-inch, (0.5 Ra micrometer) electropolished as standard.

The valve is outfitted with a sensitive PTFE Jorlon diaphragm and EPDM seats and seals that are all FDA approved, USP Class VI compliant materials. These materials of construction enable JSRFLP to withstand the rigors of an autoclave if required.

### FEATURES

- Excellent rangeability with stable outlet pressures at a variety of inlet pressures.
- Very low set point offset (droop)
- Top entry design facilitates in-line cleaning and maintenance
- Barstock construction guarantees material integrity and quality surface finish
- Four Cv's from 0.012 to 0.2 guarantee a valve that will fit your specific application
- Optimized internal volume
- Proprietary Jorlon diaphragm material provides exceptionally long life
- Soft seat material for ANSI Class VI shutoff

### DOCUMENTATION

The following documentation is shipped at no charge:

- Steriflow Unicert, a QC signed Certificate of Compliance for:
  - Material, listing heat numbers with attached MTR's
  - Surface Finish
  - FDA/USP Class VI - for all thermoplastic and elastomers
- Traceability:
  - Each individual product serial number is traceable to the Unicert serial number, heat numbers and attached MTR's

Other documents must be requested at time of RFQ, or order:

- ADI/TSE Free, Certified Test reports, Certificate of Origin.



### APPLICATIONS

The JSRFLP is a Pressure Regulating valve ideal for low flow, low pressure precision regulation of clean compressed air and gas used in pharmaceutical and biopharmaceutical R&D, Pilot, and Production facilities.

It is designed specifically for use on traditional Stainless Steel and Single Use Disposable applications including:

- Small sterile vessels:
  - Gas overlay (blanketing)
  - Sparging
  - SUD bag integrity testing/inflation
- Incubators
- Lyophilizers
- Time/pres filling machine product hold vessels

Suitable for clean compressed gas, including:

- Air
- Nitrogen
- Carbon Dioxide
- Oxygen
- Argon
- Custom gas mixtures

## SPECIFICATIONS

**Sizes:** 1/2" (DN15), 3/4" (DN20)

**End Connections:** ASME BPE

**Gauge Ports:** 1/4" FNPT is standard. Contact Factory for Tri-Clamp, VCR, or other alternatives.

**Soft Seat Materials for ANSI Class VI Shut-off**

- EPDM to +275°F (135°C), FDA & USP Class VI

**Body and Trim Material**

- ASME SA479 316L (UNS 31603) is standard. EN 10272:2000 GR 1.4435, AL-6XN®, Hastelloy®C-22 and others are optional.

**Diaphragm Material:** Jorlon - PTFE™, FDA & USP Class VI

**Maximum Inlet Pressure:**

- Tri-Clamp: 150 psig (10,3 bar)

**Optional Cleaning Specifications**

- Clean for Oil-Free
- O2 Cleaning complying with ASTM G93-03 2011 and CGA G-4.1-2009

**Pressure at Maximum Temperature:**

- Tri-Clamp: 150 psi @ 275°F (10,3 bar @ 135°C) with EPDM seats

**Surface Finish:**

- Wetted Internal surface finish: Mechanically polished, and electropolished to ASME BPE SF5, 20 Ra  $\mu\text{in}$  (0.5 Ra  $\mu\text{m}$ ) as standard
- Exterior surface finish: Mechanically polished to 40 Ra  $\mu\text{in}$  (1.0 Ra  $\mu\text{m}$ ) as standard
- Other finishes available upon request

**Maximum Pressure Drop:**

- Tube End and Tri-Clamp: 150 psi (10,3 bar)
- NPT: 150 psi (10,3 bar)

**Spring Ranges:** 2 – 18" Water (0.07 – 0.65 psi)

**FlowCapacity-Cv(Kv):** Cv 0.012, Cv 0.03, Cv 0.08, Cv 0.20 (Kv 0,010, Kv 0,026, Kv 0,069, Kv 0,173)

**Failure Cv (Kv):** Cv 0.014, Cv 0.036, Cv 0.096, Cv 0.240 (Kv 0,0121, Kv 0,0311, Kv 0,083, Kv 0,2075)

**Options**

- Oxygen cleaning and certification
- Panel Mounting
- Gauge Ports, Pressure Gauges

**Note:** For a complete ancillary list of all wetted and un-wetted material specifications, please contact Steriflow Valve.

## OPTION DEFINITION

### Panel Mount

Contact factory if required.

### Gauge Ports - Pressure Gauge

Inlet pressure gauges are available as standard options

**ANTI-TAMPER OPTION - CONTACT FACTORY**

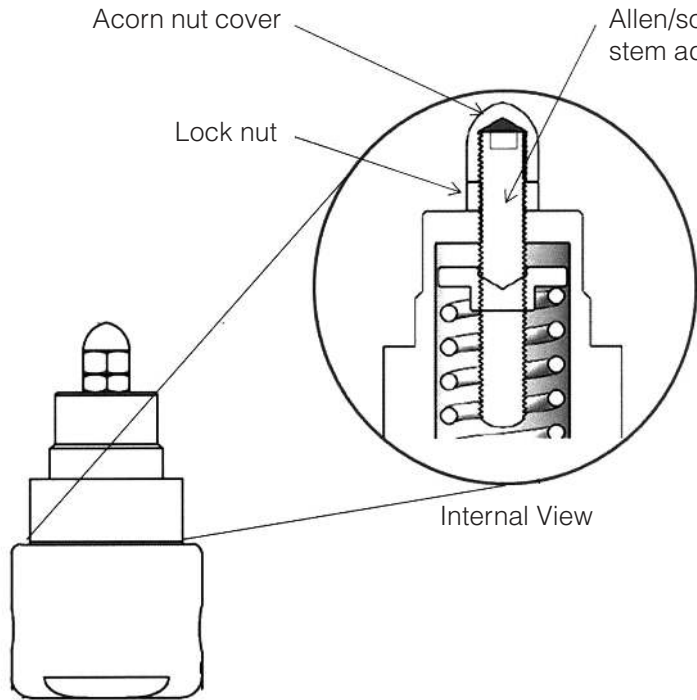

1. Adjust stem position with Allen wrench
2. Tighten lock nut against bonnet while holding stem position
3. Replace and tighten acorn nut

**DIN & ISO TRI-CLAMP DIMENSIONS**

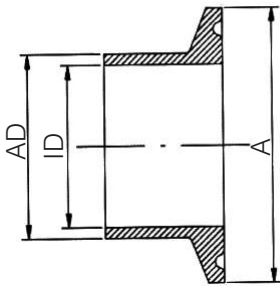

**DIN 32676 Row B (ISO 1127)**

VALVE SIZE	A	AD	ID
DN15	50.5	21.3	18.1
DN15*	34.0	21.3	18.1
DN20	50.5	26.9	23.7

\* with non-standard Tri-clamp face

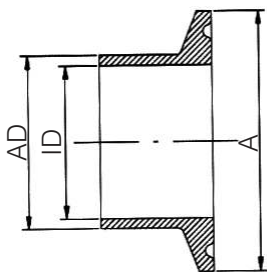

**DIN 32676 Row A (DIN 11850)**

VALVE SIZE	A	AD	ID
DN15	34.0	19.0	16.0
DN15*	50.5	19.0	16.0
DN20	34.0	23.0	20.0
DN20*	50.5	23.0	20.0

\* with non-standard Tri-clamp face

### FEATURES & BENEFITS

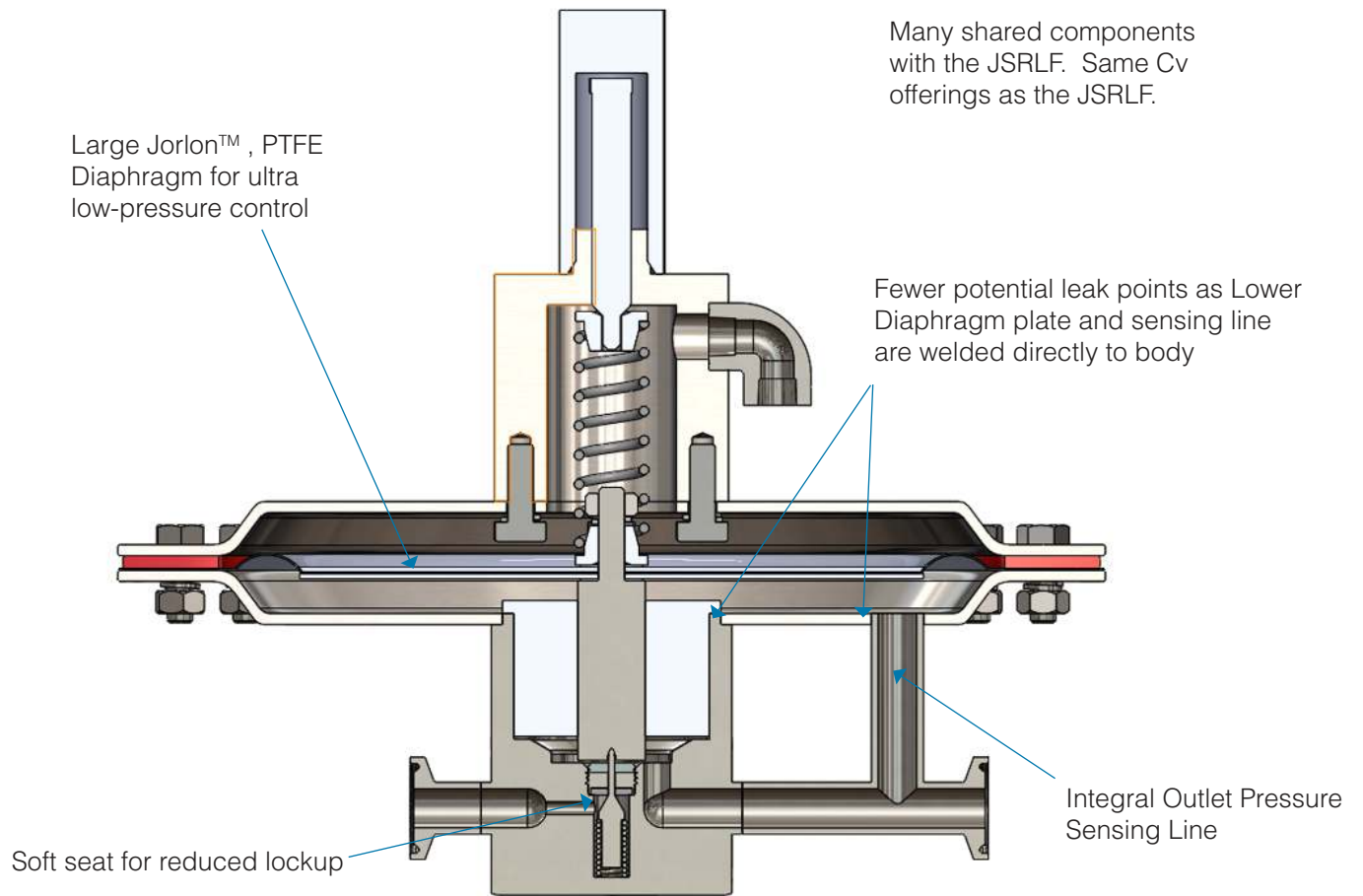

### FLOW CONFIGURATIONS/ GAUGE PORTS

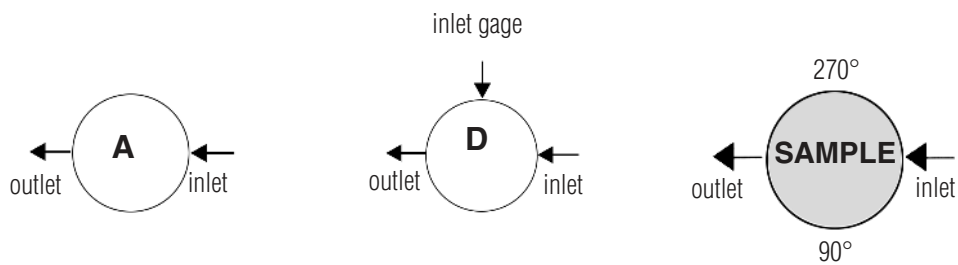

\* Gage ports are 1/4" FNPT as standard. Consult factory for Tri-Clamp, VCR, or other port options.

**DIMENSIONS 1/2" JSRLFULP HIGH PURITY GAS PRESSURE REDUCING VALVE  
F/ LOW FLOW & ULTRA LOW PRESURE 1/2" ASME BPE TRI-CLAMP ENDS**

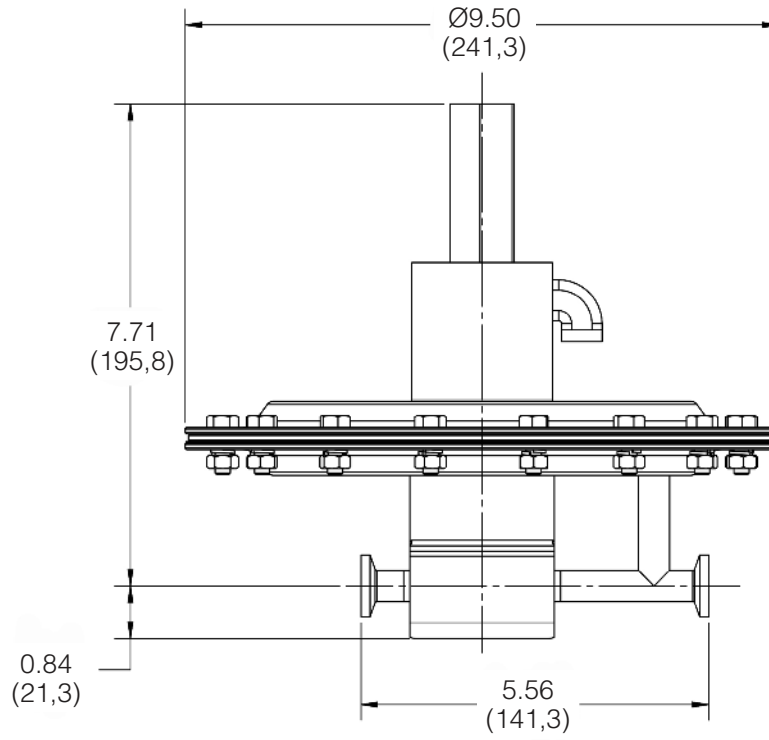

**DIMENSIONS 3/4" JSRLFULP HIGH PURITY GAS PRESSURE REDUCING VALVE  
F/ LOW FLOW & ULTRA LOW PRESURE 3/4" ASME BPE TRI-CLAMP ENDS**

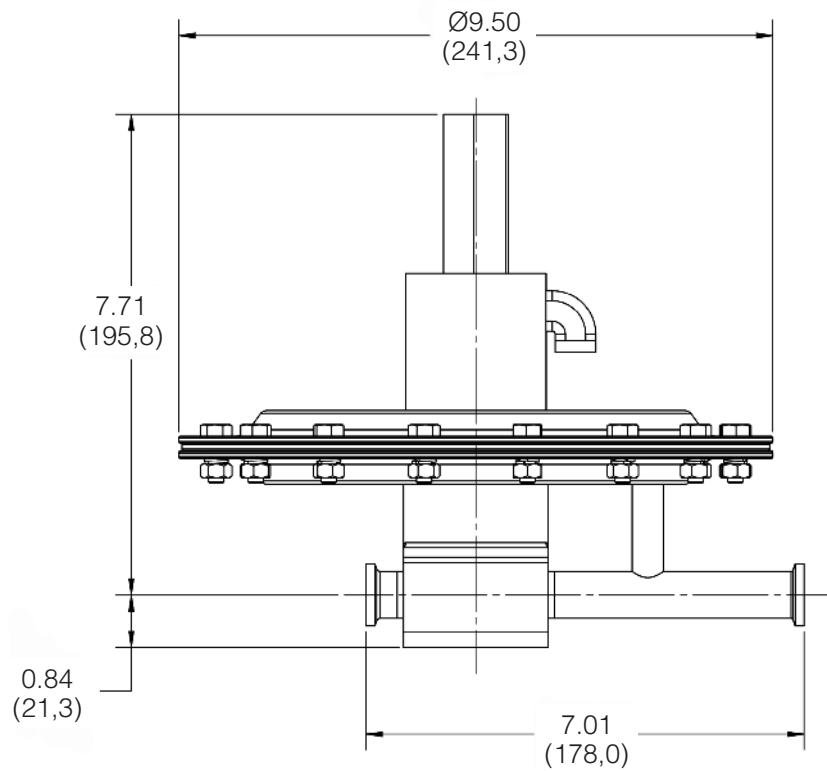

## CV TRIM SELECTION INSTRUCTIONS

To select a valve with the proper Cv:

1. Select a graph on the following thirteen pages that best represents your outlet pressure set point and flow range
2. Looking at that graph, select the closest inlet pressure line (horizontal sloped line, P1) that best reflects your application's actual inlet pressure. That line indicates the Pressure/Flow capabilities and offset (droop) of the trim (Flow Coefficient, Cv) under flowing conditions.  
**Note:** If your exact outlet pressure set point or inlet pressure is not listed you will have to interpolate.
  - Your particular inlet pressure line will be very similar in length and slope to the line chosen on any particular graph.
  - The same is true for your outlet pressure set point, simply shift the line up or down.
3. The Cv is listed in bold at the upper left of the page of your chosen graph. You will need that for model number selection (See page 21).

## GAS CONVERSION FACTORS

To convert gas flow rates to the air flow rates shown in the following graphs, multiply the gas flows by the conversion factor listed below.

For example: to convert an Argon flow range of 0.17 to 1.7 LPM to equivalent air flow rates that you can use with the graphs below, multiply each Argon flow rate by 1.18. The air flow range equivalent would be: (0.17 LPM Argon x 1.18) to (1.7 LPM Argon x 1.18), or 0.2 LPM Air to 2.0 LPM air.

Argon 1.18  
Carbon Dioxide 1.23  
Nitrogen 0.98  
Oxygen 1.05

**FLOW DATA FOR Cv TRIM SELECTION**

The graphs illustrate the change or "droop" in outlet pressures as the flow rate increases, and the lockup (setpoint rise) as flow decreases and approaches zero.

Flow Coefficient: 0.012

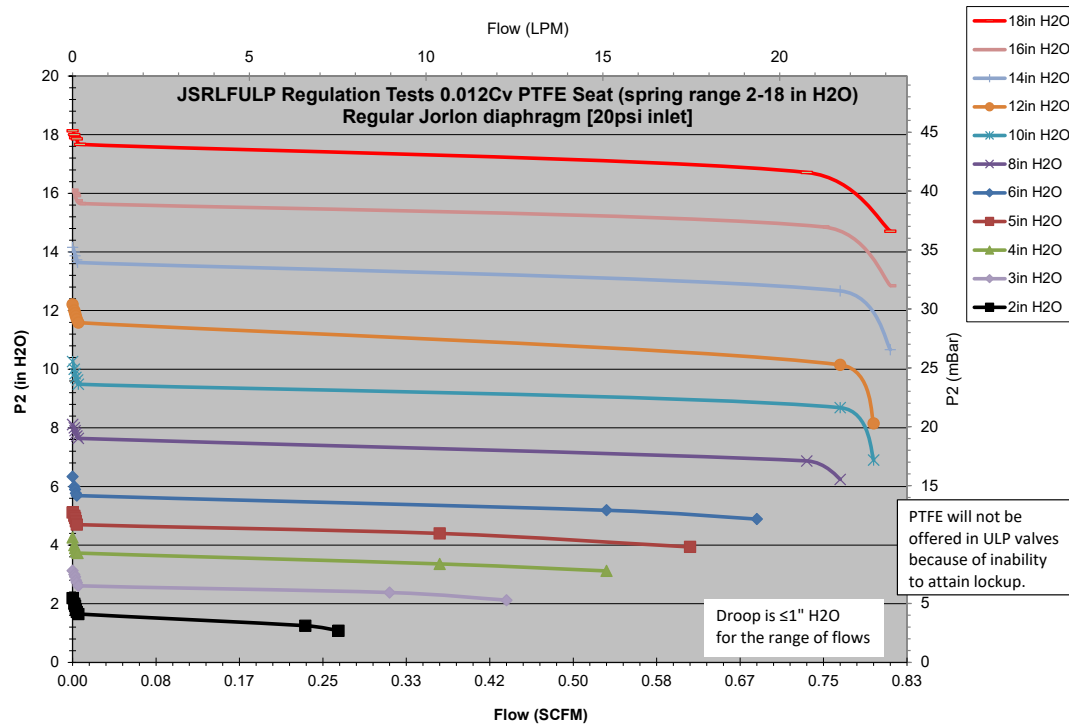
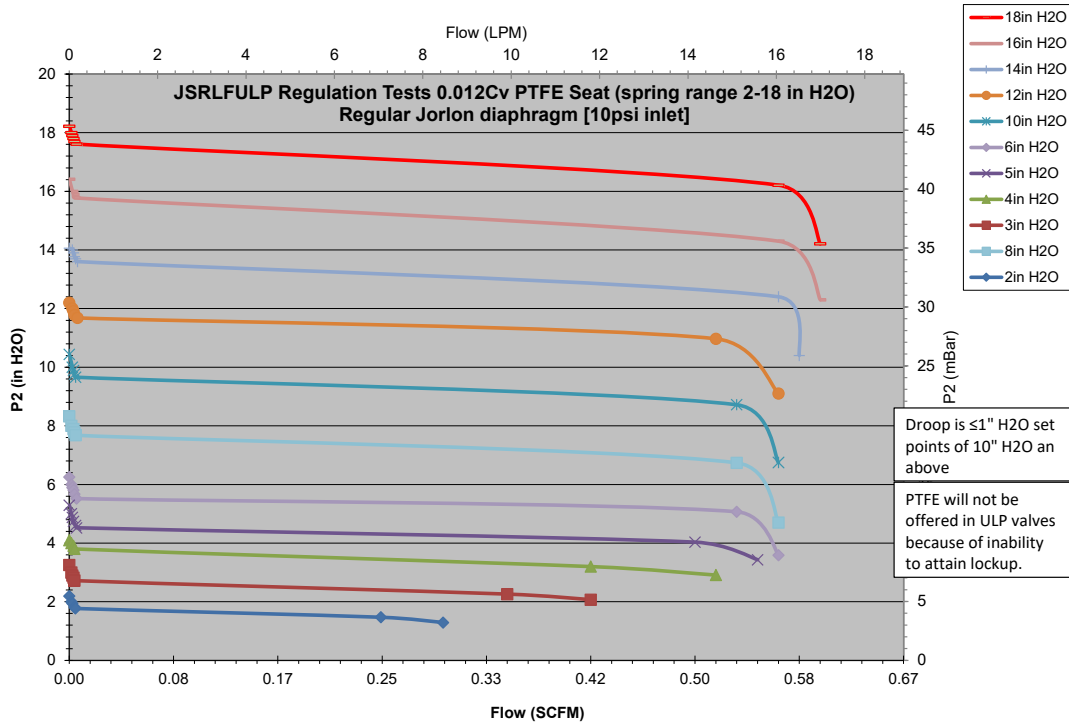

FLOW DATA FOR Cv TRIM SELECTION

The graphs illustrate the change or "droop" in outlet pressures as the flow rate increases, and the lockup (setpoint rise) as flow decreases and approaches zero.

Flow Coefficient: 0.012

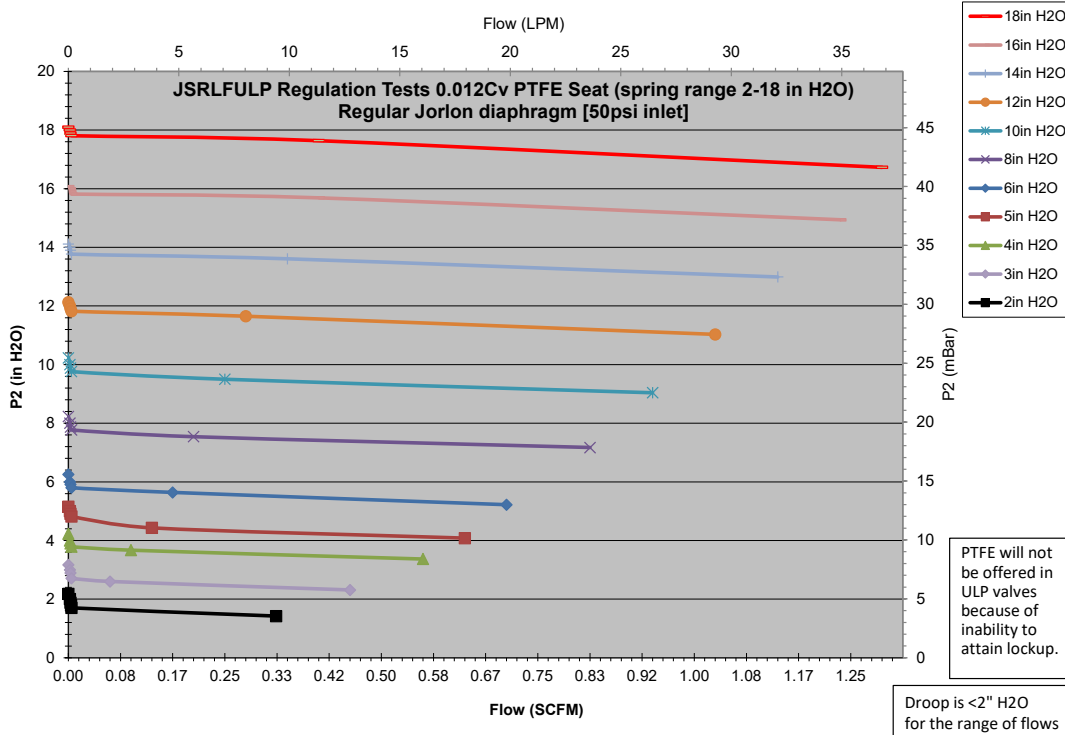
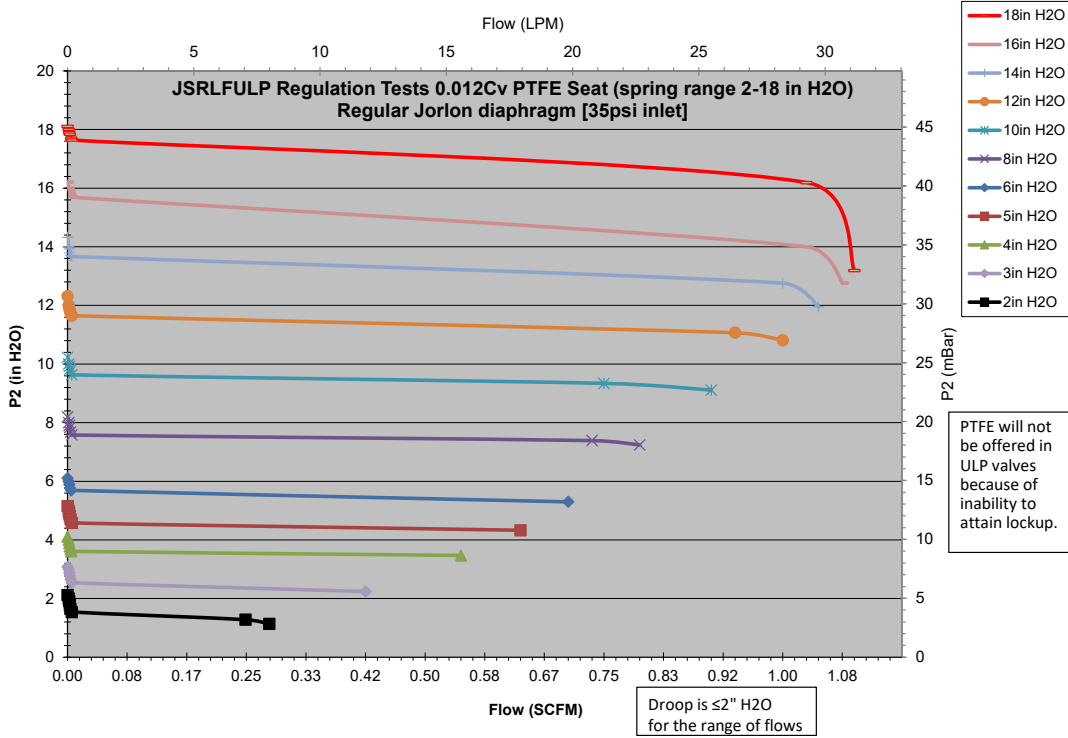



**FLOW DATA FOR Cv TRIM SELECTION**

The graphs illustrate the change or "droop" in outlet pressures as the flow rate increases, and the lockup (setpoint rise) as flow decreases and approaches zero.

Flow Coefficient: 0.012

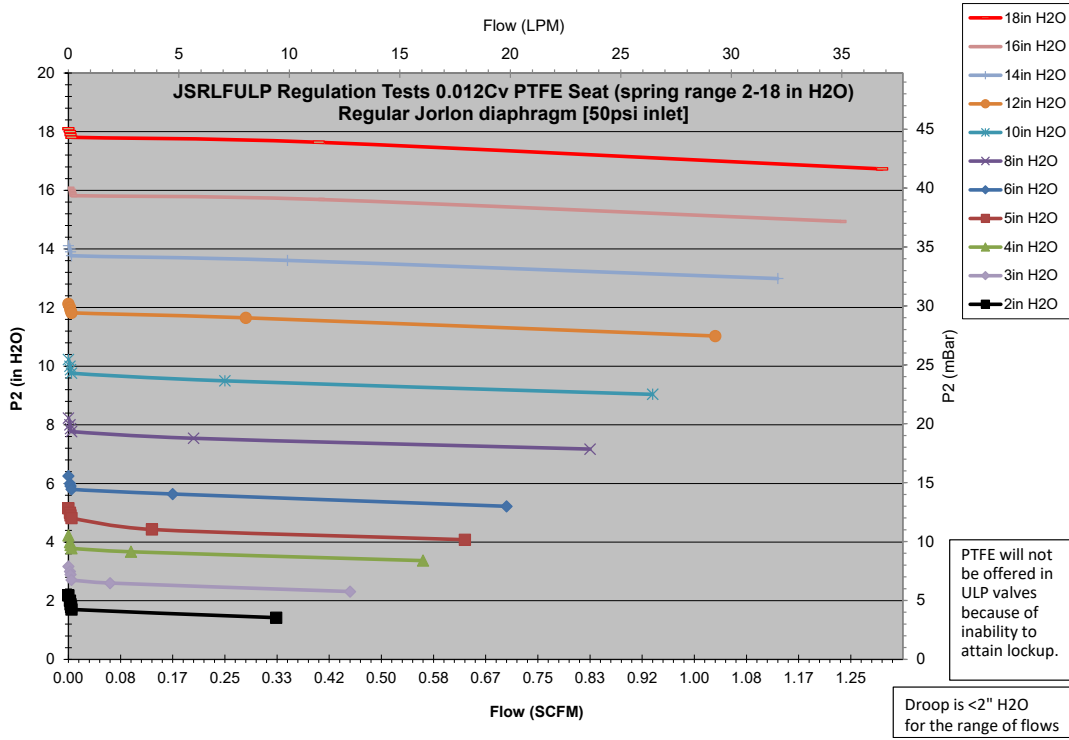

Flow Coefficient: 0.03

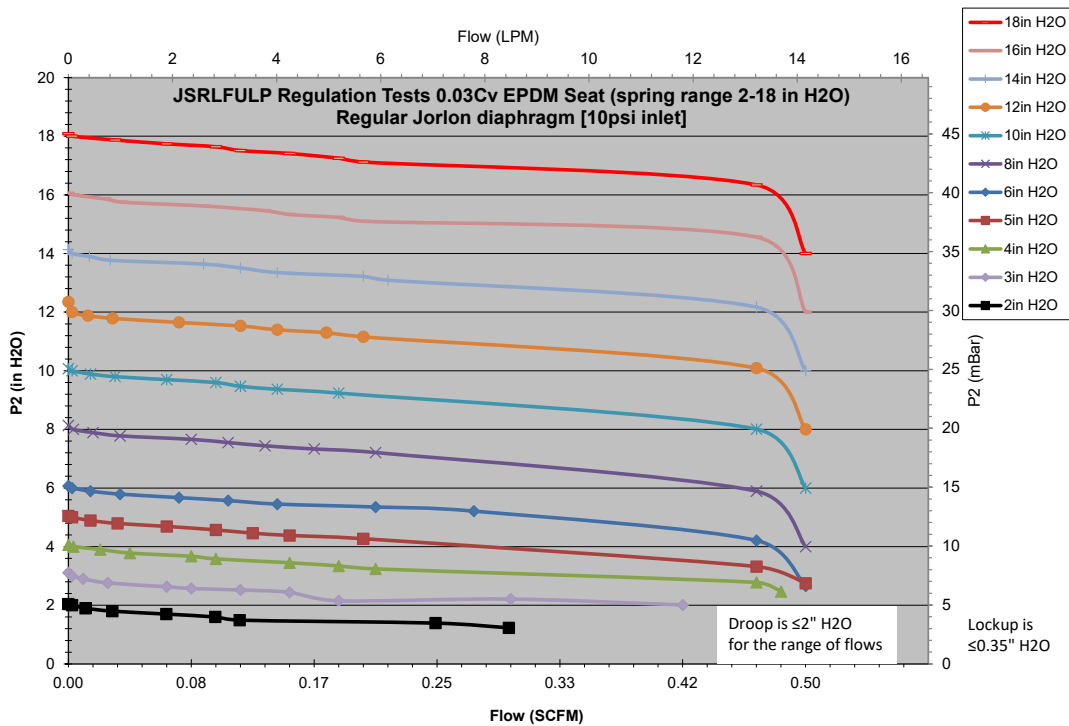

FLOW DATA FOR Cv TRIM SELECTION

The graphs illustrate the change or "droop" in outlet pressures as the flow rate increases, and the lockup (setpoint rise) as flow decreases and approaches zero.

Flow Coefficient: 0.03

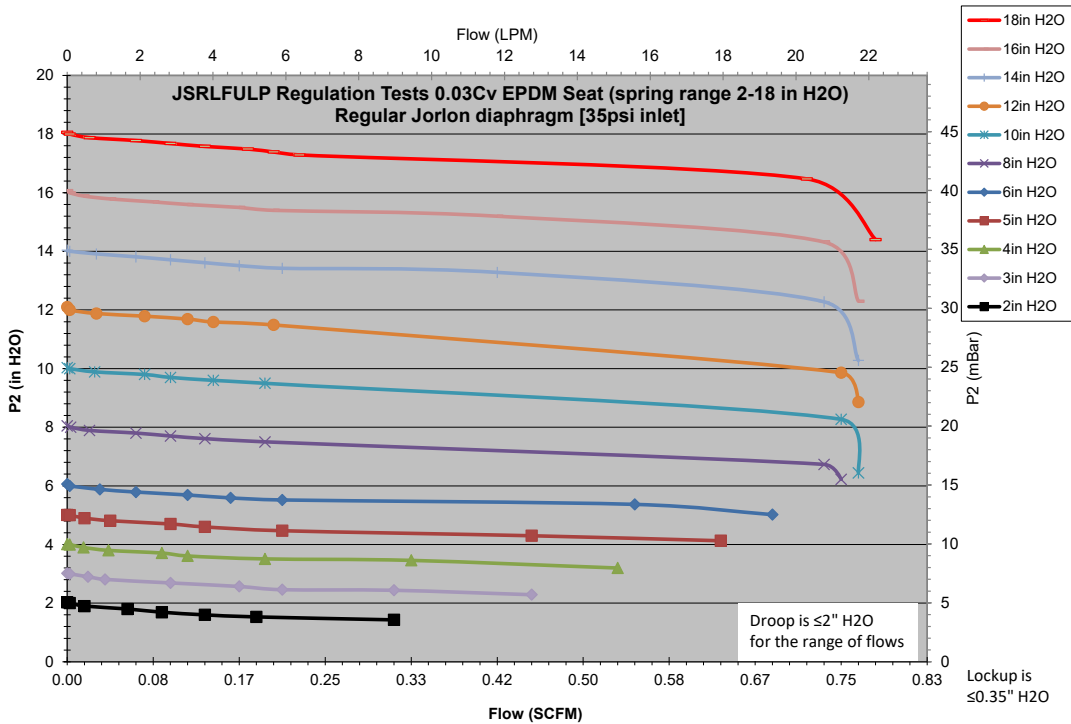
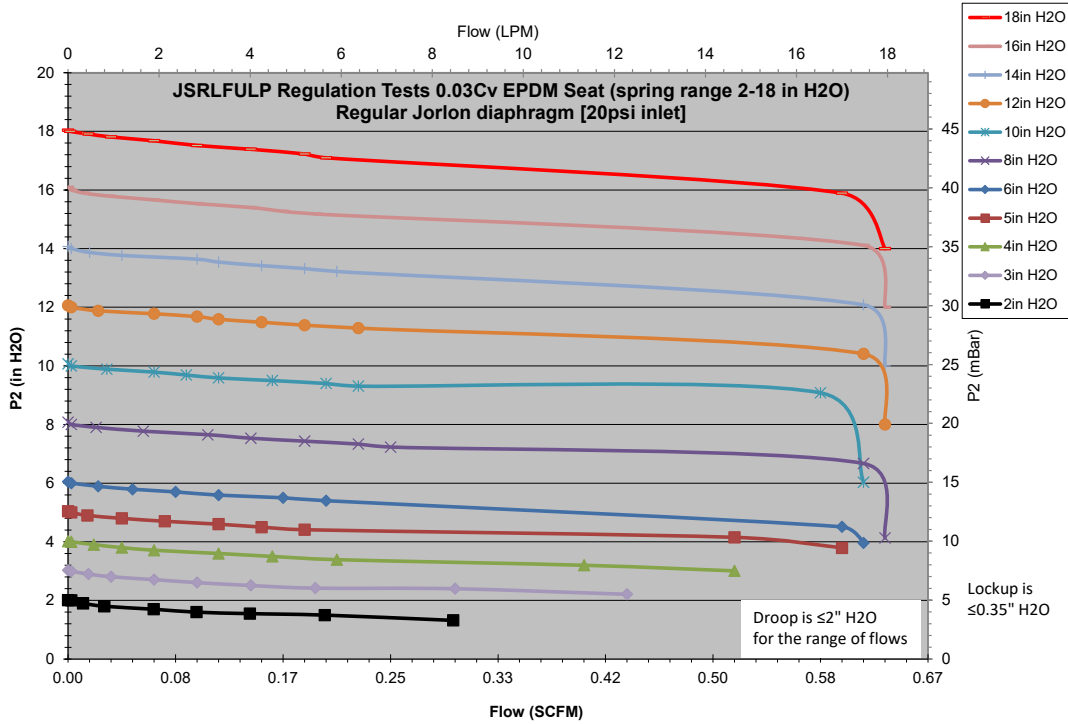

FLOW DATA FOR Cv TRIM SELECTION

The graphs illustrate the change or "droop" in outlet pressures as the flow rate increases, and the lockup (setpoint rise) as flow decreases and approaches zero.

Flow Coefficient: 0.03

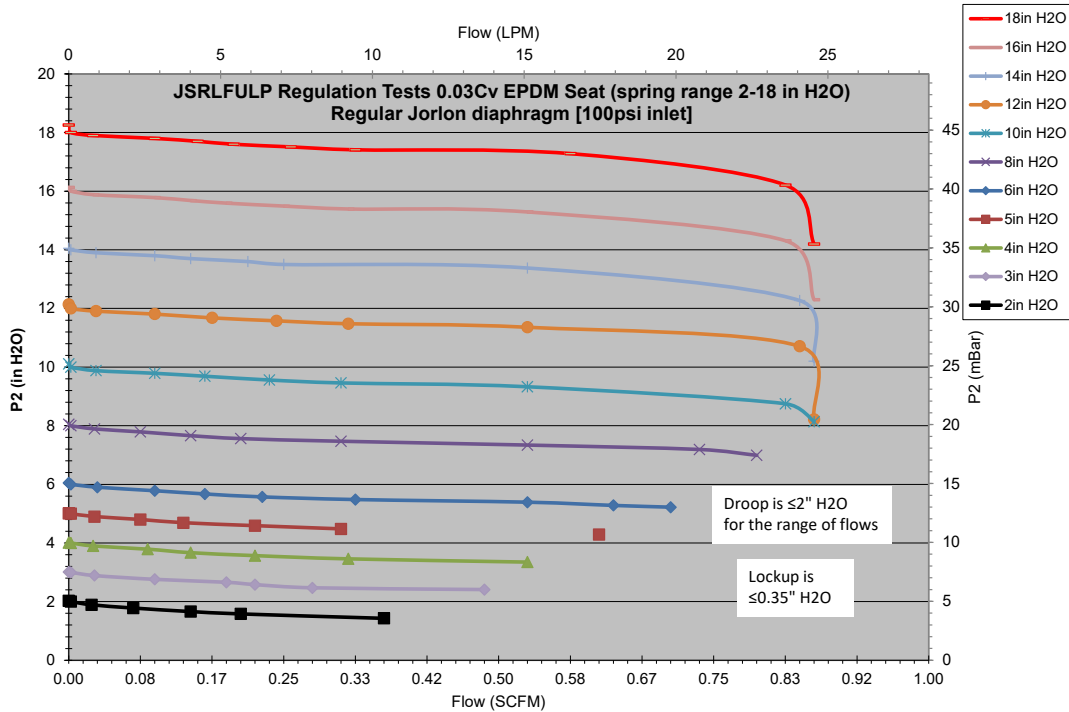
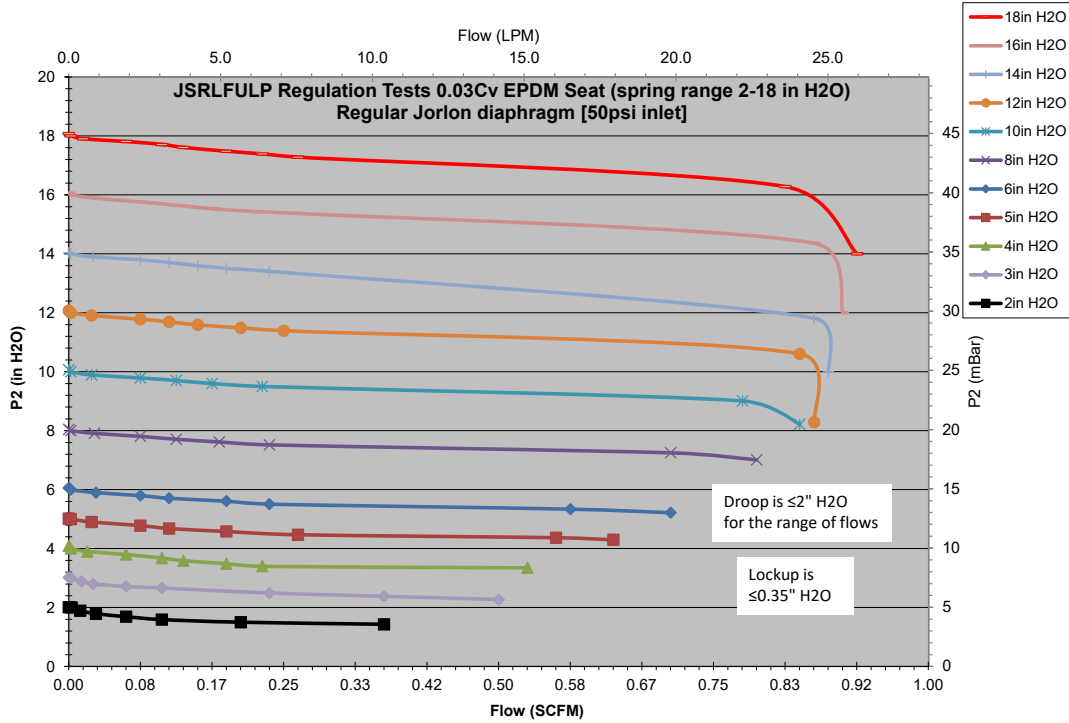

FLOW DATA FOR Cv TRIM SELECTION

The graphs illustrate the change or "droop" in outlet pressures as the flow rate increases, and the lockup (setpoint rise) as flow decreases and approaches zero.

Flow Coefficient: 0.08

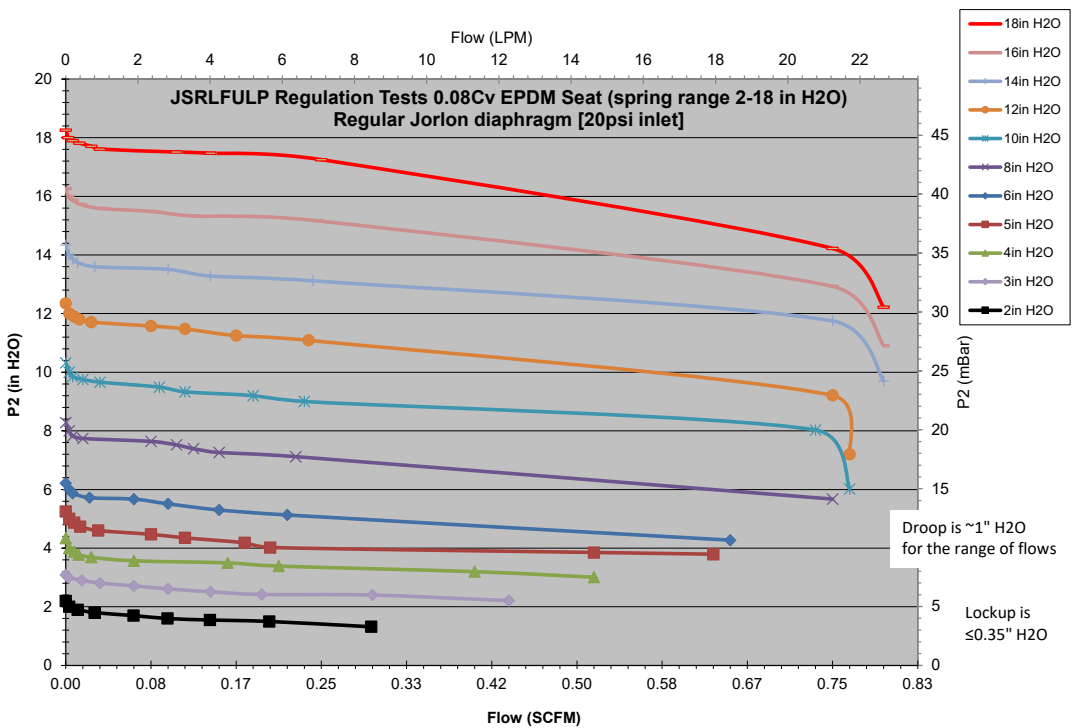
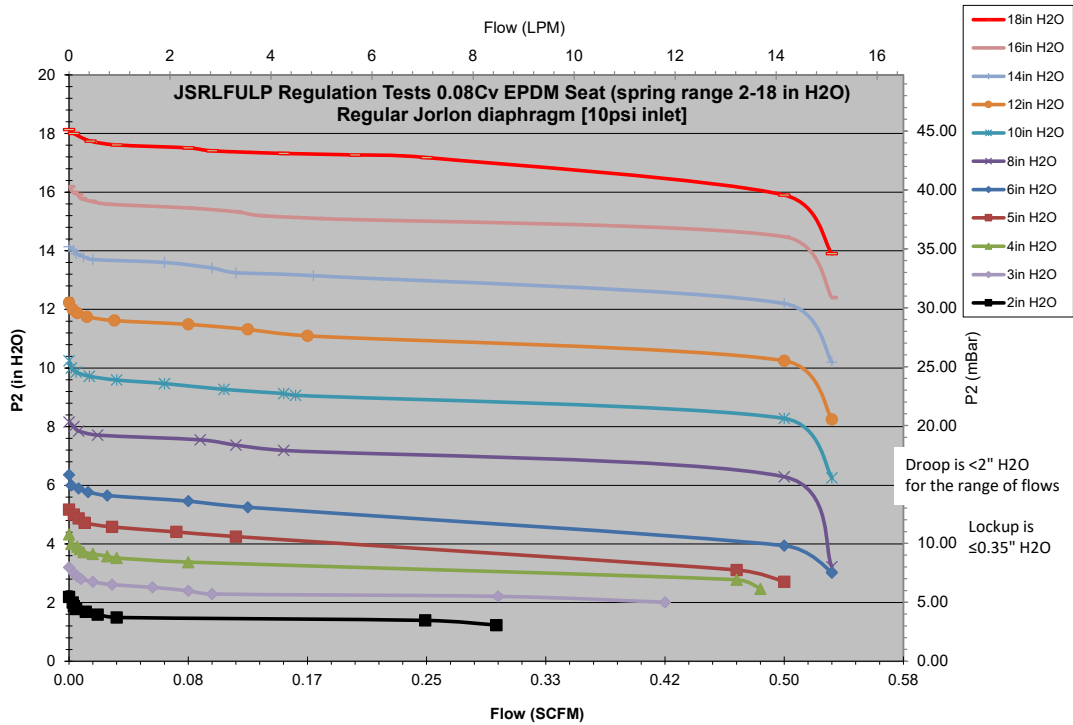

**FLOW DATA FOR Cv TRIM SELECTION**

The graphs illustrate the change or "droop" in outlet pressures as the flow rate increases, and the lockup (setpoint rise) as flow decreases and approaches zero.

Flow Coefficient: 0.08

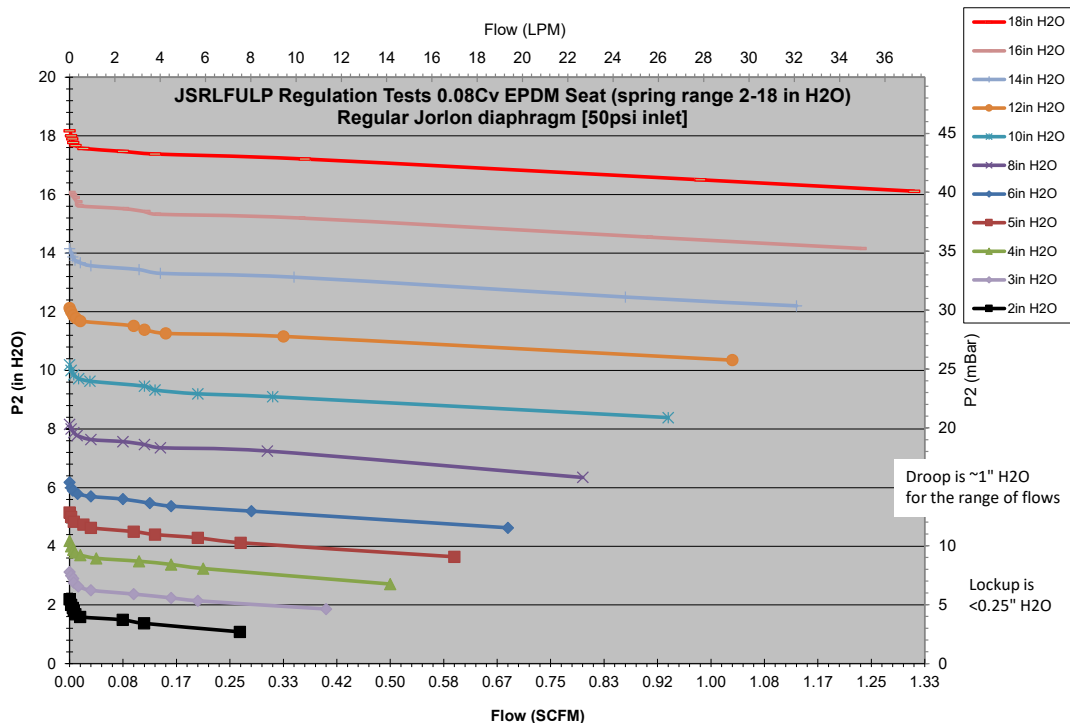
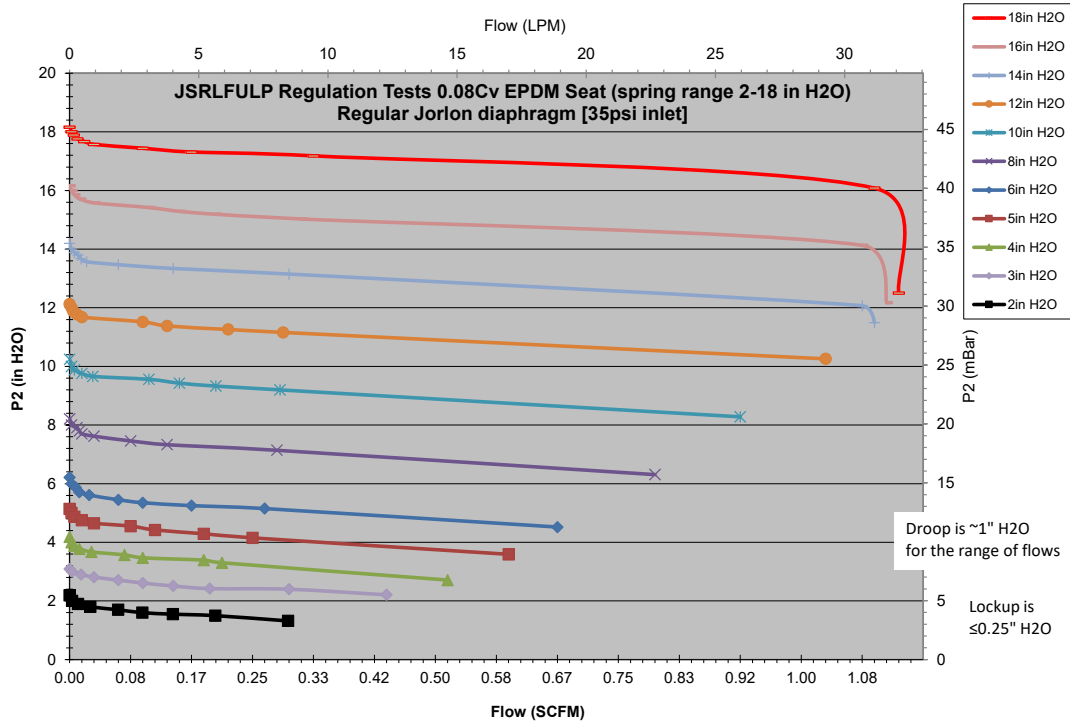

FLOW DATA FOR Cv TRIM SELECTION

The graphs illustrate the change or "droop" in outlet pressures as the flow rate increases, and the lockup (setpoint rise) as flow decreases and approaches zero.

Flow Coefficient: 0.08

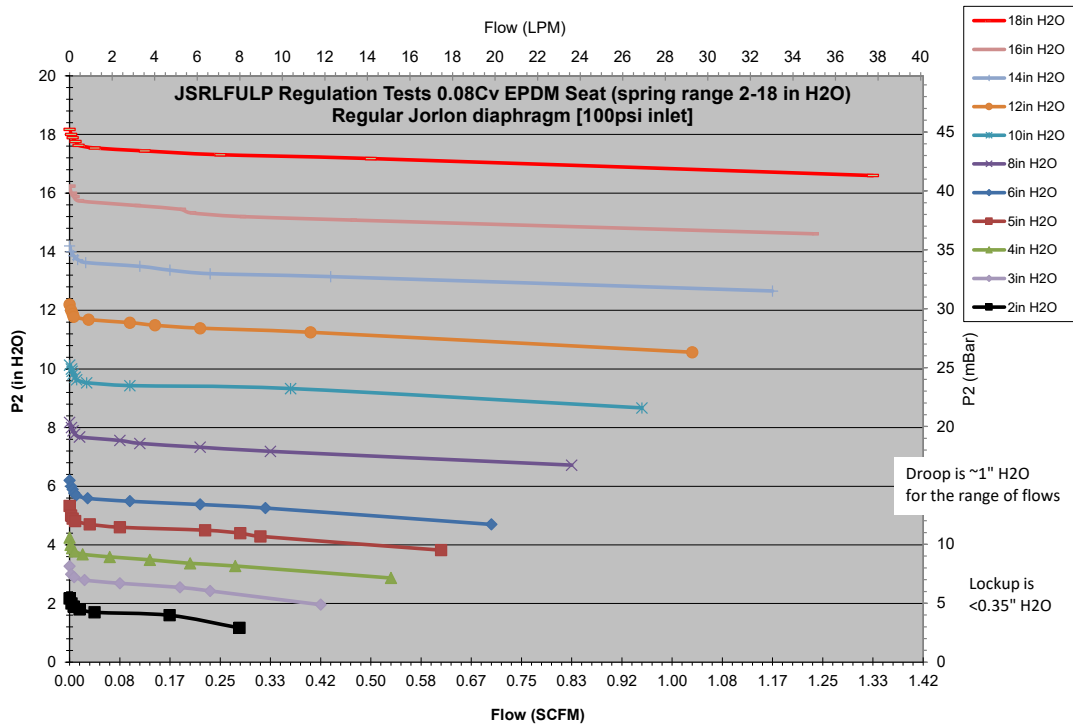

Flow Coefficient: 0.2

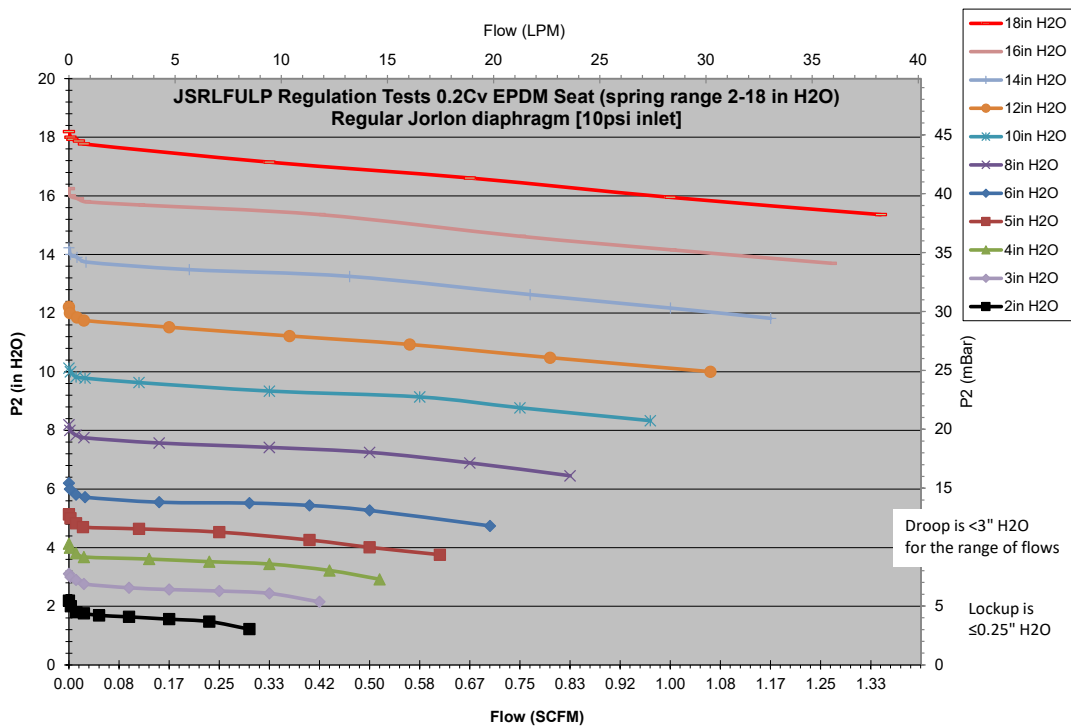

FLOW DATA FOR Cv TRIM SELECTION

The graphs illustrate the change or "droop" in outlet pressures as the flow rate increases, and the lockup (setpoint rise) as flow decreases and approaches zero.

Flow Coefficient: 0.2

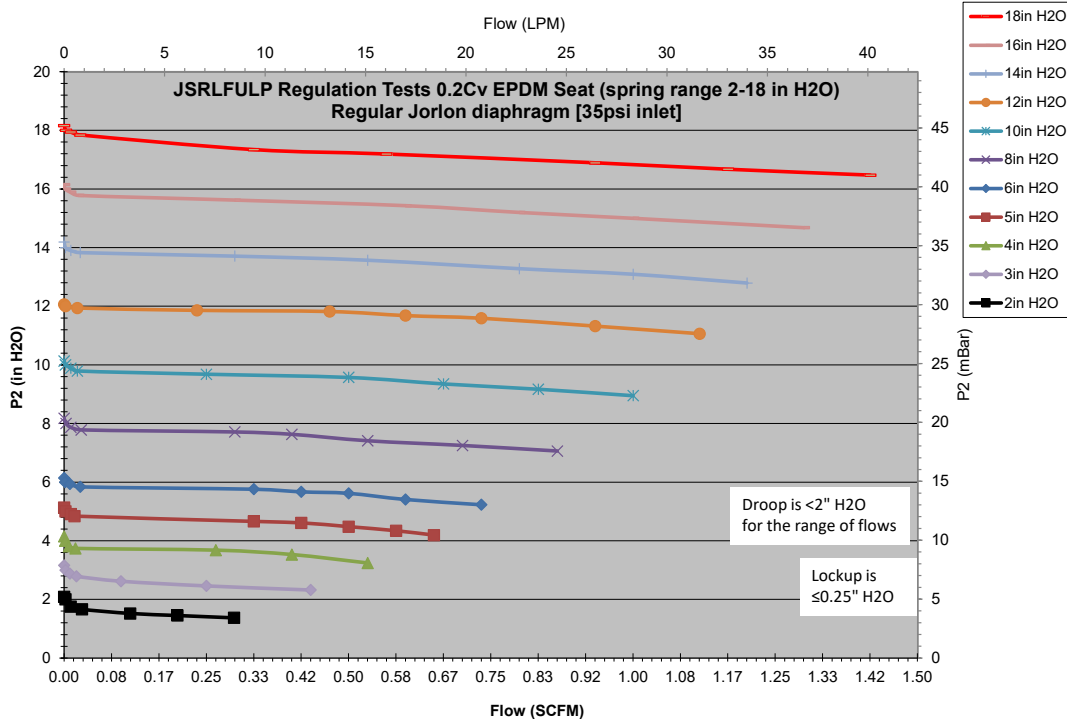
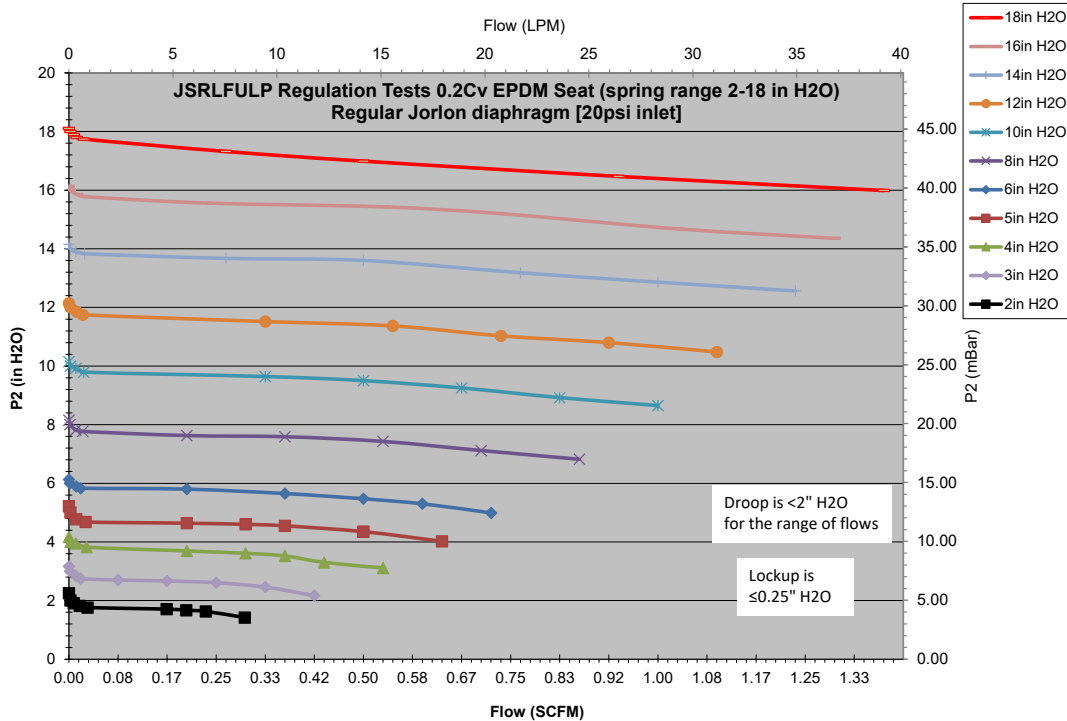

FLOW DATA FOR Cv TRIM SELECTION

The graphs illustrate the change or "droop" in outlet pressures as the flow rate increases, and the lockup (setpoint rise) as flow decreases and approaches zero.

Flow Coefficient: 0.2

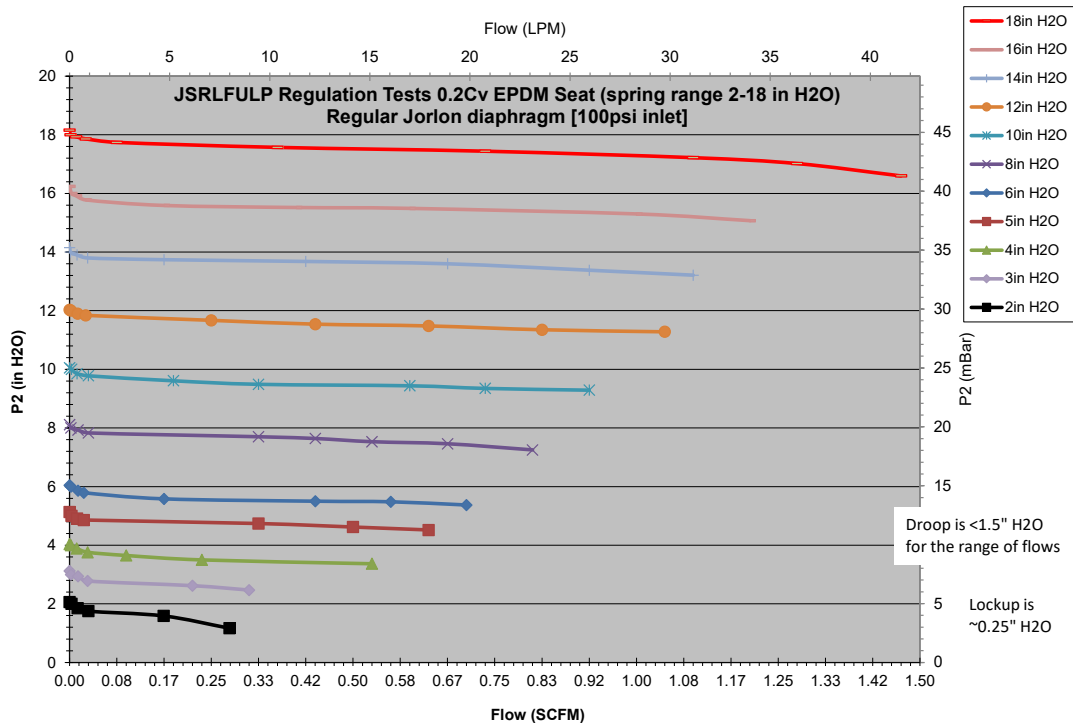
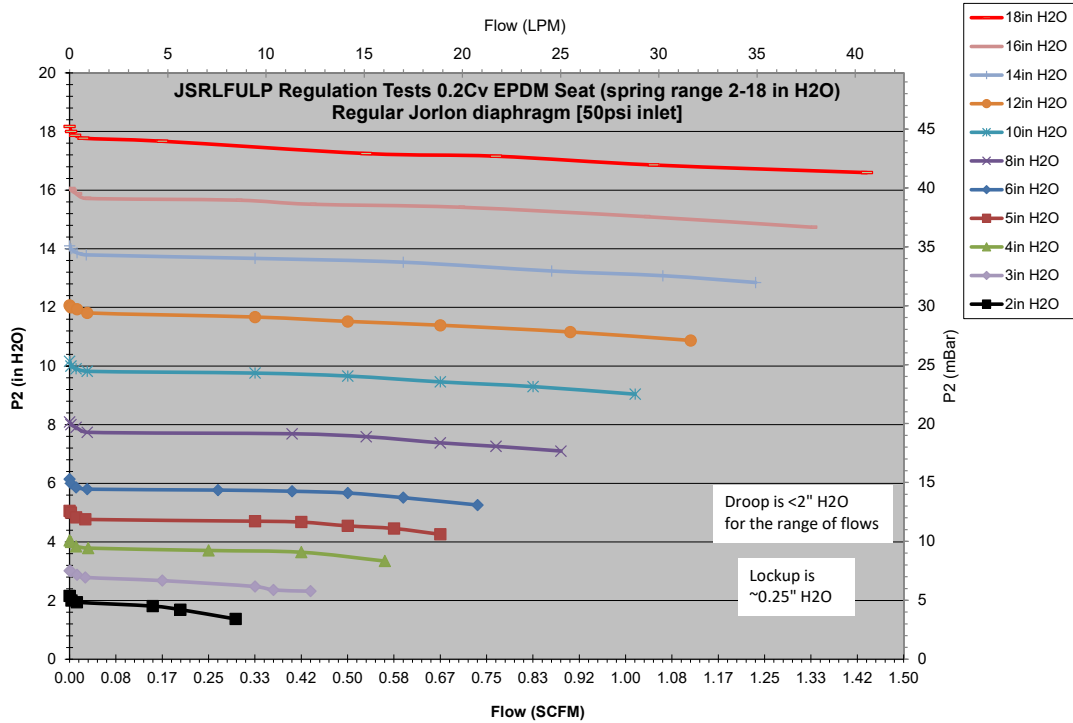



JSRLFULP SERIES LOW FLOW LOW PRESSURE REDUCING VALVE

JSRLFULP ORDERING SCHEMATIC

Model	Size	Material	/	1 & 2	3 & 4	5 & 6	7 & 8	9 & 10	11 & 12	13 & 14	15	16	17
	—	—											

Model	
JSRLFULP	Low Flow Low Pressure Reducing Valve

Size	
050	1/2" (DN15)
075	3/4" (DN20)

Material	
6L	Stainless Steel 316L

1 & 2 Body Feature			
End Connection		Port Configuration	
2S	Tri-Clp 20 Ra EP	A	Port "A"

3 & 4 Trim	
1S	Cv 0.012
2S	Cv 0.03
3S	Cv 0.08
4S	Cv 0.20
ZZ	Non-Standard

5 & 6 Seat Material	
D1	EPDM Cv 0.012
D2	EPDM Cv 0.08
D3	EPDM Cv 0.20
D4	EPDM Cv 0.03
ZZ	Non-Standard

7 & 8 Range	
A8	2 - 18" WC

9 & 10 Diaph Material	
GL	Standard Jorlon
ZZ	Non-Standard

11 & 12 Actuator	
SK	Standard Act.
ZZ	Non-Standard

13 & 14 Inlet Gauge	
ØB	0-30 PSIG/BAR (Dual)
ØC	0-60 PSIG/BAR (Dual)
ØD	0-100 PSIG/BAR (Dual)
ØE	0-160 PSIG/BAR (Dual)
ØN	None
ØZ	Non-Standard

15 Outlet Gauge	
ØN	None
ØZ	Non-Standard

16 SEP Compliance	
G	SEP Compliant
Ø	None
Z	Non-Standard

17 Accessories	
S	Clean for Oil Free
X	Clean for Oxygen
A	EN10204 3.1 Cert all Wet
Ø	None
Z	Non-Standard

**JSRLFULP REPAIR KIT ORDERING SCHEMATIC**

Model	Size	Material	Kit	/	1	2	3	4	5	6	7
	—	—	—								

Model	
JSRLFULP	Low Flow Low Pressure Reducing Valve

Size	
050	1/2" (DN15)
075	3/4" (DN20)

Material	
6L	Stainless Steel 316L

1 & 2	Trim
1S	Cv 0.012
2S	Cv 0.03
3S	Cv 0.08
4S	Cv 0.2
ZZ	Non-Standard

3 & 4	Seat Material
D1	EPDM Cv 0.012
D2	EPDM Cv 0.08
D3	EPDM Cv 0.20
D4	EPDM Cv 0.03
ZZ	Non-Standard

5 & 6	Diaph Assy.
SJ	Standard Jorlon
ZZ	Non-Standard

7	Accessories
S	Clean for Oil Free
X	Clean for Oxygen
0	None
ZZ	Non-Standard

*Steriflow Valve reserves the right to make revisions to its product, specifications, literature and related information without notice. Please visit our website at [www.steriflowvalve.com](http://www.steriflowvalve.com) for the latest information on our products.*



**Steriflow by Jordan Valve**  
3170 Wasson Road • Cincinnati, OH 45209  
513.533.5600 • 800.543.7311 • 513.871.0105 (f)  
[steriflow@richardsind.com](mailto:steriflow@richardsind.com) • [www.steriflowvalve.com](http://www.steriflowvalve.com)